

DCPXXX

CUSTOMER DWG

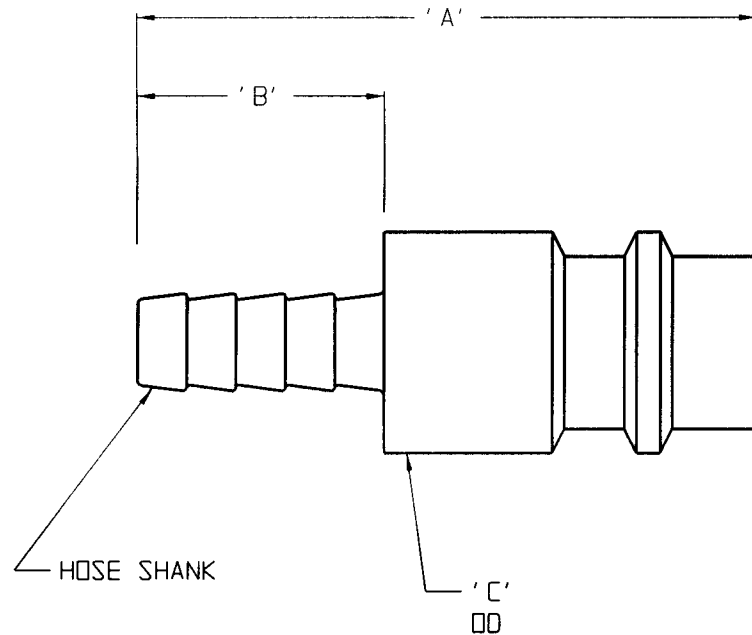

NOTES:

- 1) ALL PART NUMBERS ENDING IN B ARE BRASS, ALL OTHERS ARE STEEL.

AGREEMENT TO MAINTAIN CONFIDENTIALITY

This drawing is owned by Dixon Valve & Coupling Co. and shall be returned upon demand. It is loaned on condition that it shall not be copied or reproduced or submitted to others without the owners consent. In accepting it subject to this condition the recipient further agrees that this drawing or any design detail or concept disclosed herein shall not be used in any way detrimental to or in competition with the Owner. If the recipient does not agree to the terms of this agreement, they shall return this drawing immediately.



The Right Connection™

PLUG SIZE	PART NO	' A '	' B '	' C '	SHANK
1/2"	DCP1746	3"	1 1/2"	15/16"	3/4"
1/2"	DCP1745	2 3/8"	15/16"	11/16"	1/2"
1/2"	DCP1744	2 3/8"	15/16"	11/16"	3/8"
3/8"	DCP2545	2 1/16"	15/16"	11/16"	1/2"
3/8"	DCP2544	2 3/16"	15/16"	5/8"	3/8"
3/8"	DCP2542	2 1/16"	15/16"	11/16"	1/4"
1/4"	DCP2144 DCP2144B	1 15/16"	1"	9/16"	3/8"
1/4"	DCP2143	1 15/16"	1"	9/16"	5/16"
1/4"	DCP2142 DCP2142B	2 1/8"	1"	9/16"	1/4"
PLUG SIZE	PART NO	' A '	' B '	' C '	SHANK

CUSTOMER DWG

**DIXON VALVE & COUPLING CO.
U. S. A.**

TITLE 'AIR CHIEF' INDUSTRIAL QUICK-CONNECT FITTINGS HOSE SHANK PLUGS

DRAWN BY: 12-11-96
ANDREW JINKS

CHECKED BY:

APPROVAL: *JTB*
10/23/02

MAT'L

SEE NOTE 1

DCPXXX