

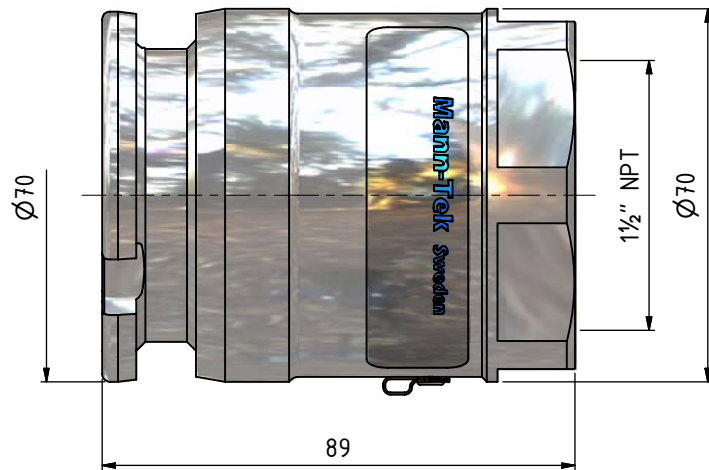

Notice: This drawing contains proprietary information and shall not be used or reproduced or its contents disclosed in whole or in part, without the prior written consent of the Mann-Technik AB

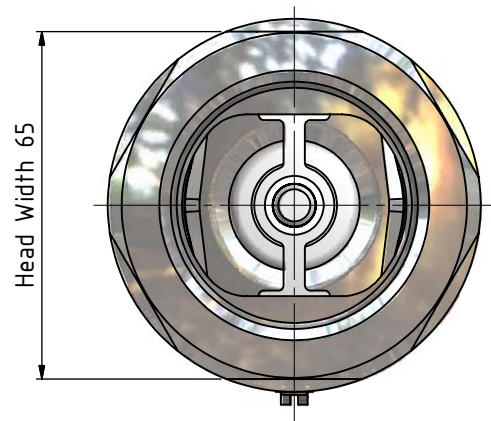

Dimensions are in metric.

Detail No:	Material	Ytbeh./Treatment	
	Designed/drawn by P. Nyberg	Scale: 1:1	Dimension with no tolerances acc to Machined SS-ISO 2768-1 medium Weld Forge SS-ISO 2768-1 coarse Surface roughness ISO 1302 Form & position tol SS ISO 1101
	Checked G. Kopplin	Date 2007-05-15	
	Approved T. Mann		
Tank Unit 2" Connection: 1 1/2" NPT			Data nr./Comp No. T208A4401 Blad/Sheet 1 / 1
			Drawing No. T208A1101-1 Rev.

NO.	Revision comprises	Date	Sign.	Appr by
-----	--------------------	------	-------	---------